



**HELEN O'GRADY  
DRAMA ACADEMY**

**UPPER PRIMARY  
ACTIVITY PACK  
WEEK 12**

COLOUR IN THE OLYMPIC SCENE AND BRING TO DRAMA!

DRAW HOW THE WINNING OLYMPIANS ARE FEELING AFTER WINNING.

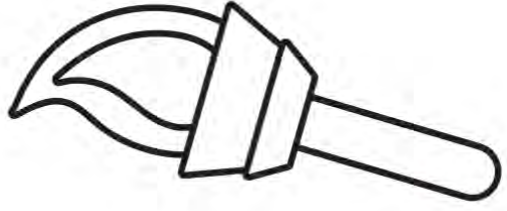
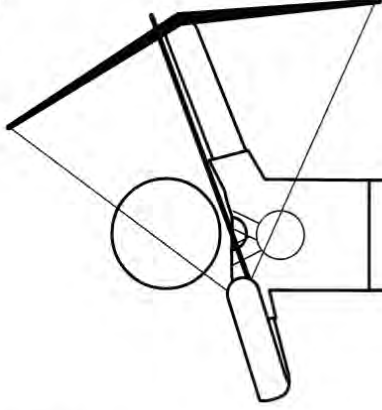
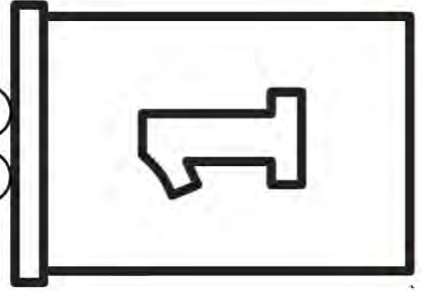
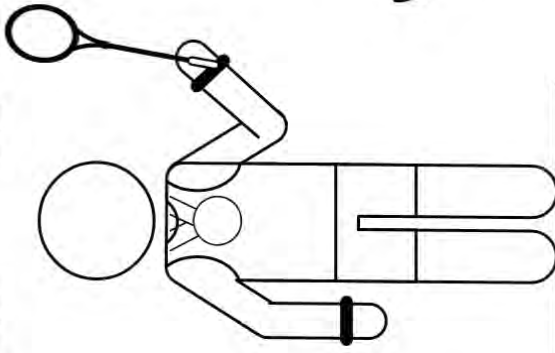
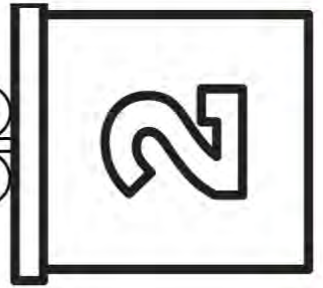
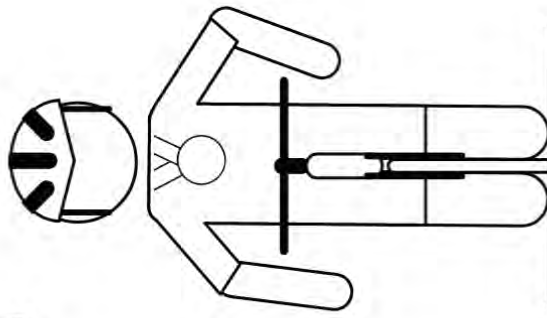
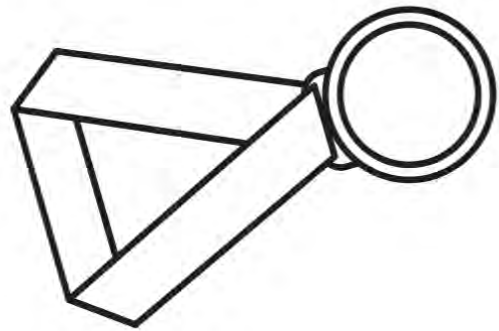
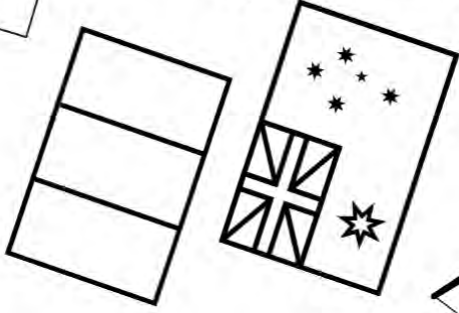
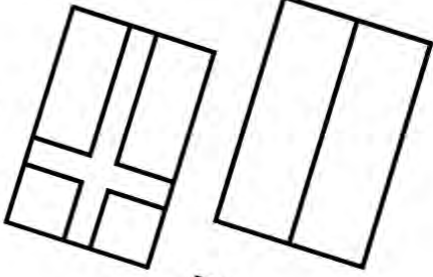
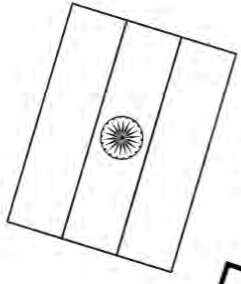
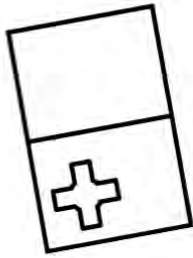
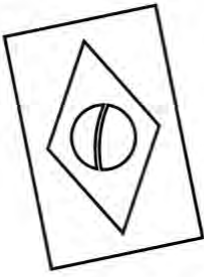
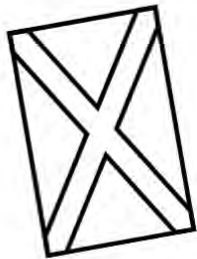
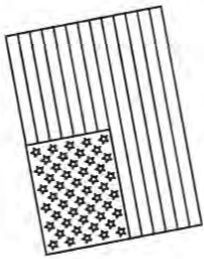

# WORD SCRABBLE

UNSCRAMBLE THESE WORDS ABOUT THE OLYMPICS

1. E T H A T E L

---

2. L M C I Y P O H R O T C

---

3. D I M T A U S

---

4. W D R C O

---

5. D O G L , V R S E L I & E O R N B Z

---

6. Y M E N O C R E

---

7. C I P Y L O M O D R C R E

---



# DESIGN A SPORTS JERSEY

WHAT SPORT, COUNTRY OR TEAM WILL IT BE FOR?

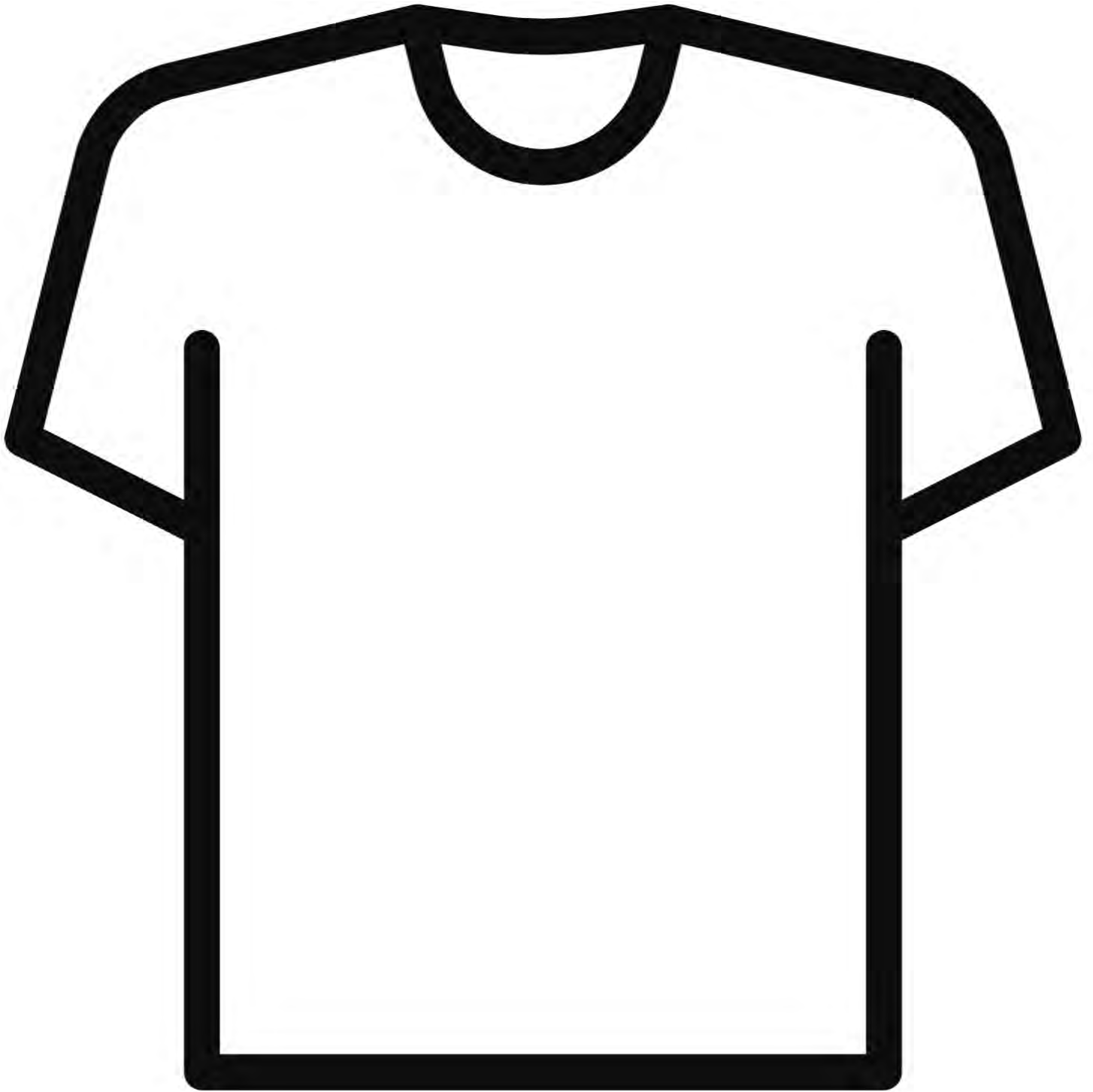

# DEVELOPMENT THROUGH ONLINE DRAMA

Our structured curriculum and trained teachers guarantee the highest standard of interactive online drama classes.

## **Benefits of Our Online Classes for Students Include:**

- Increased SELF ESTEEM and CONFIDENCE
- SOCIAL INTERACTION and COMMUNICATION with others
- FUN activities to engage CREATIVITY and IMAGINATION
- SPEECH and LANGUAGE development

*"The online lesson was amazing! It's been the best learning experience by far since lockdown began."*

## **JOIN US FOR A FREE TRIAL CLASS**

Please contact us for further information and a brochure:

EMAIL: HO @ HELENOGRADY.CO.UK

TEL: 0845 603 7220

WEBSITE: WWW.HELENOGRADY.CO.UK

